



KENWOOD

BASIC C1

STEREO CONTROL AMPLIFIER

SERVICE MANUAL

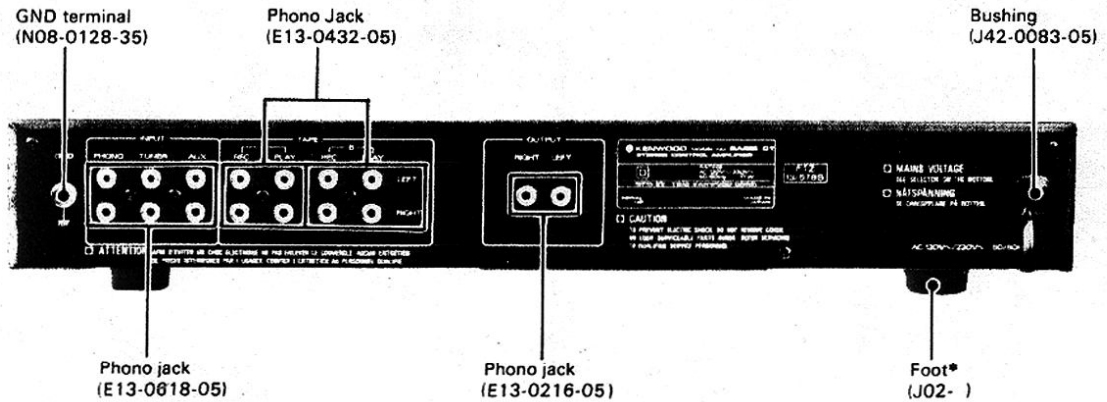
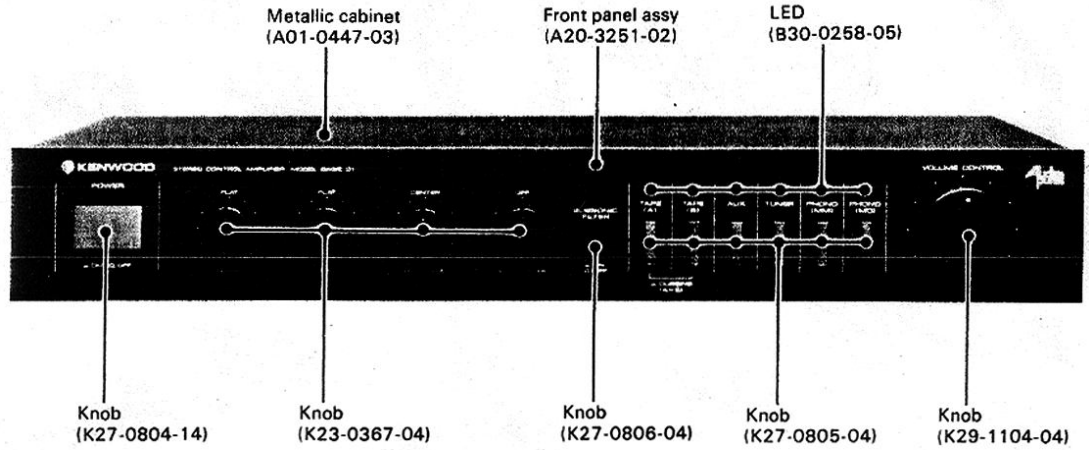

*Refer to parts list on page 4.

EXPLODED VIEW

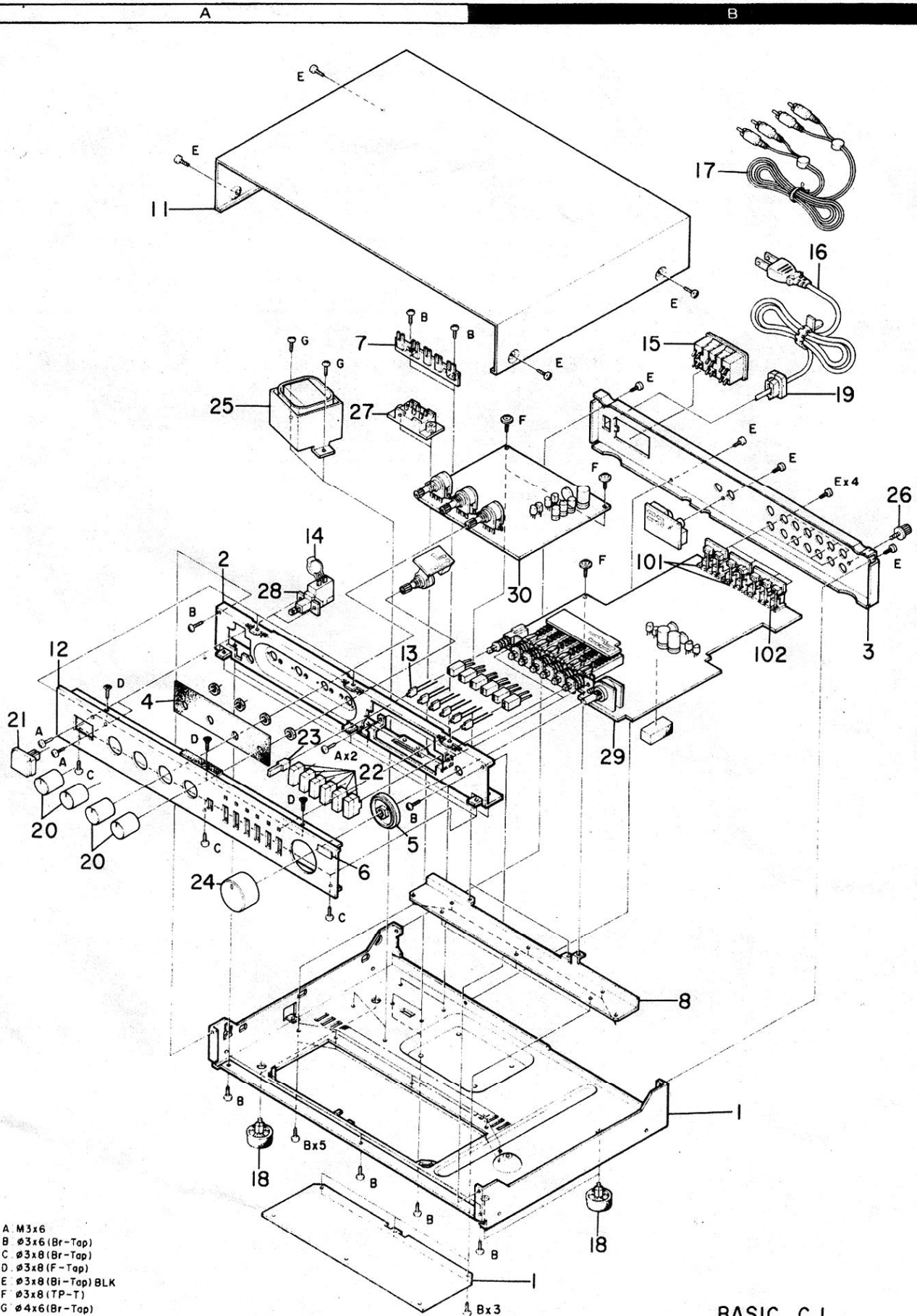

BASIC C I

PRE AMP (X08-2010-10)
Component side view

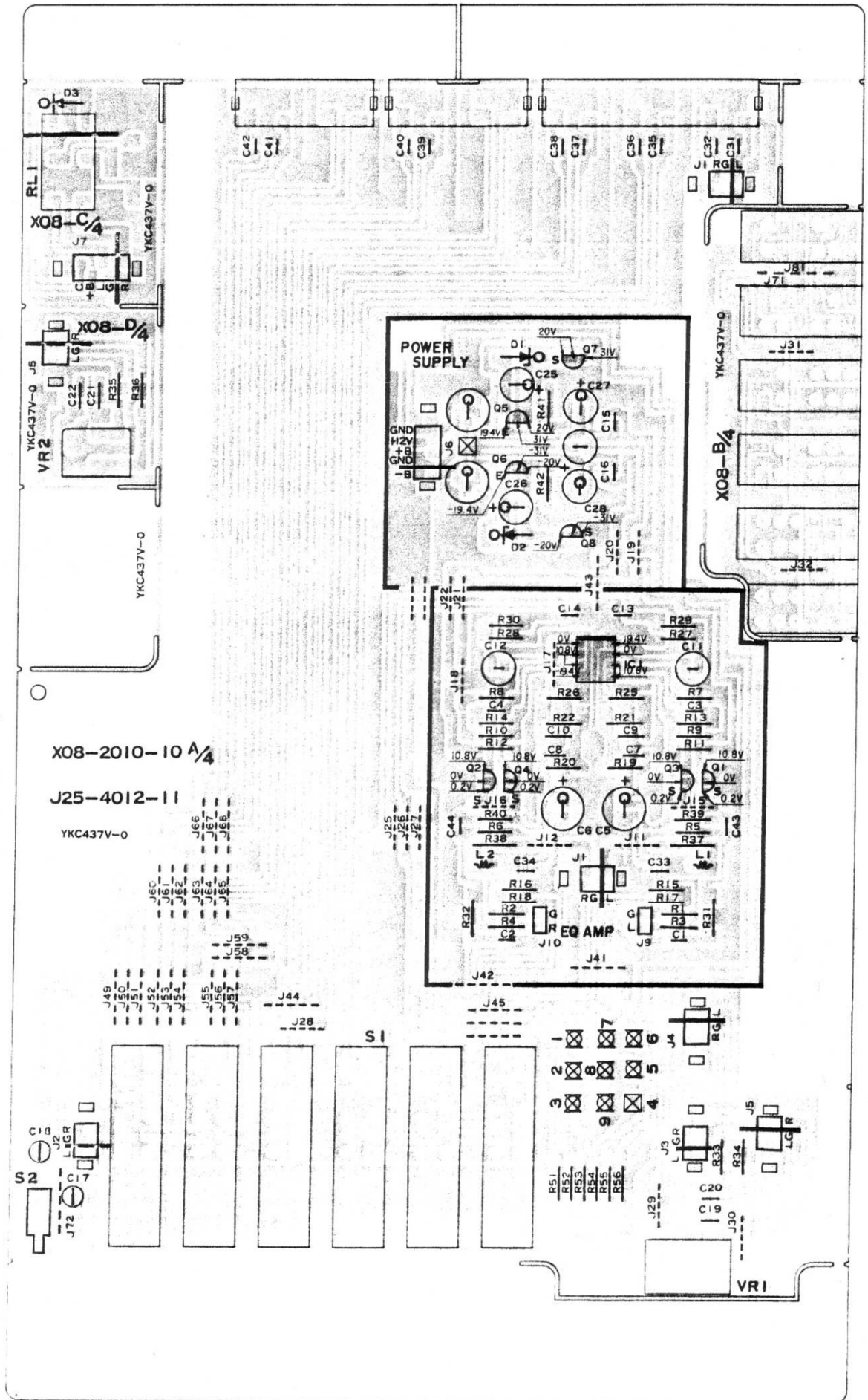

BOARD

TONE AMP (X11-1750-10) Component side view

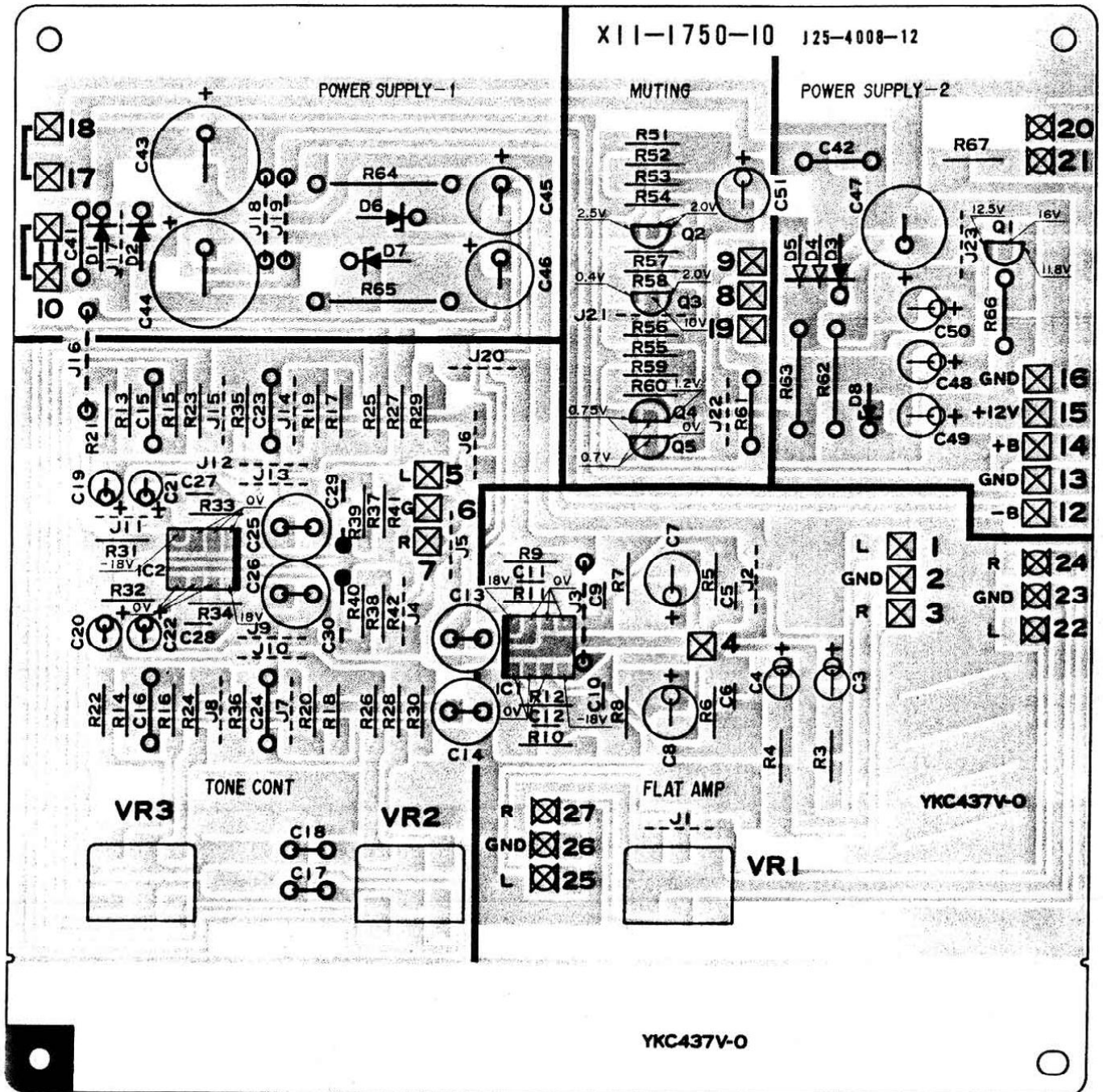

In this model, there are separated pc boards which was originally one. These separated pc boards can't be supplied independently.

- ex. X09-1230-00 (A/3)
- X09-1230-00 (B/3)
- X09-1230-00 (C/3)

Parts no. of pc board

Separated portion no.

In the example shown above, separated portion can't be ordered independently.

In case only A/3 was ordered, pc board ass'y of X09-123-00, which all A/3, B/3, C/3 included, will be shipped.

Refer to the schematic diagram for the values of resistors and capacitors. The PC board drawing is viewing from the side easy to check.

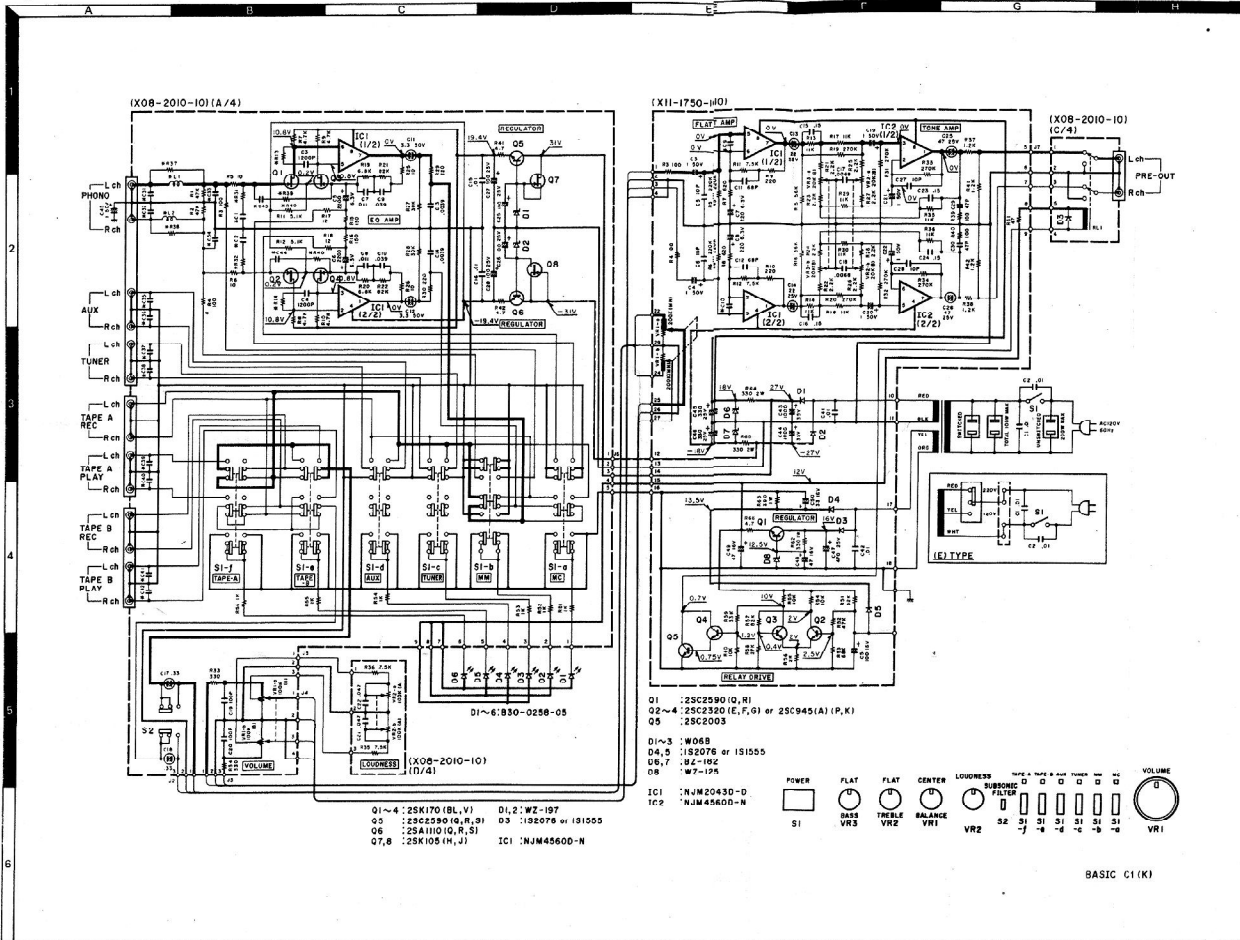

SPECIFICATIONS

PERFORMANCE

Input Sensitivity/Impedance/Signal-to-Noise Ratio (IHF A Curve)
 Phone 1 (for MM use) 2.5 mV/47 kohms/87 dB
 Phone 2 (for MC use) 0.25 mV/100 kohms/70 dB
 Tuner/AUX 150 mV/47 kohms/108 dB
 Tape Play 150 mV/47 kohms/108 dB

Maximum Input Voltage for Phone 1 200 mV (RMS), 1 H.D. 0.005% at 1.00 kHz

Maximum Input Voltage for Phone 2 15 mV (RMS), 1 H.D. 0.005% at 1.00 kHz

Frequency Response
 Phone 1 & 2 RIAA Standard Curve ±0.3 dB
 100 Hz - 20 kHz
 1 Hz - 200 kHz (-3 dB)
 18 Hz, 6 dB/Octave

Tuner, AUX & Tape Play
 Subsonic Filter 18 Hz, 6 dB/Octave

Transient Response
 Rise Time 1.4 µs

Total Harmonic Distortion
 Tuner, AUX & Tape Play 0.004% at 1 V Output
 Phone 1 (for MM use) 0.006% at 1 V Output (VOLUME at -30 dB)
 Phone 2 (for MC use) 0.009% at 1 V Output (VOLUME at -30 dB)

Output Voltage & Impedance
 Maximum Output 5 V
 Load Impedance 47 kohms
 Loadwise Control let VOLUME -30 dB 0 to +9 dB Continuously Variable

GENERAL

Power Requirement 50 Hz 120 V (U.S.A. & Canada Model)
 Model sold elsewhere incorporates switch to accommodate 50/60 Hz 120 V/220 V
 0.15A

Power Consumption 1 Unswitched, 2 Switched
 W 440 mm (17.5") 10"
 H 38 mm (1.5") 5.62"
 D 328 mm (12.9") 7.32"
 4.2 kg (9.3 lbs)
 4.8 kg (10.6 lbs)

Kenwood follows a policy of continuous advancements in development. For this reason specifications may be changed without notice.

Kenwood poursuit une politique de progrès constants en ce qui concerne le développement. Pour cette raison, les spécifications sont sujettes à modifications sans préavis.

Kenwood strebt ständige Verbesserungen in der Entwicklung an. Daher bleiben Änderungen der technischen Daten jederzeit vorbehalten.

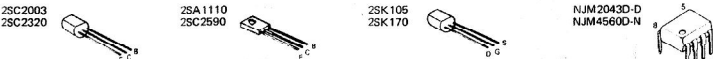

- DC voltages are measured by a VOM of 20 kΩ/V input impedance.
- Les tensions de courant continu sont mesurées par un multimètre d'une impédance d'entrée de 20 kΩ/V.
- Die Gleichstrom-Spannungen werden durch ein Vielfachmeßgerät von 20 kΩ/V Einwärts-Impedanz gemessen.

* New Parts

Parts without Parts No. are not supplied.
Les articles non mentionnés dans le Parts No. ne sont pas fournis.
Teile ohne Parts No. werden nicht geliefert.

PARTS LIST

INSTRUCTION FOR PARTS LIST

Ref. No. 参照番号	Parts No. 部品番号	Description 部品名 / 規格	Re- marks 備考
② ① 1 3A 2 2A 3 2A 4 1A,1B 5 1A	- - - - A20-1666-08	MAIN CHASSIS ASS'Y FRONT CHASSIS FLUOR DISPLAY HOLDER FRONT PANEL FRONT PANEL ASS'Y	③ ④
⑤ PS3 RS1 RL1	S42-3201-08 S01-1204-08 S51-2204-08	PUSH SW. (SELECTOR) 111 ROTARY SW. (FUNC.) 105 RELAY FIG.104	①

- ① Exploded view drawing No.
- ② Position in exploded view.
- ③ Symbol of new parts
- ④ Area to which parts are shipped. Example: A20-1666-08 is the part No. of FRONT PANEL ASS'Y for the "K" type products (for U.S.A.). When this column is blank, it means that the same type of parts (same parts No.) are used for the products shipped to all areas.
- ⑤ Reference No. in schematic diagram.
- ⑥ Abbreviation of "ceramic capacitor"

- All capacitors and resistors are listed using abbreviations.
Abbreviations
- * Abbreviations of capacitors (Parts No. with initial letter "C").
 - ELECTRO** Electrolytic capacitor
 - LL-ELEC** Low leak electrolytic capacitor
 - NP-ELEC** Non-pole electrolytic capacitor
 - MICA** Mica capacitor
 - POLYSTY** Polystyrene capacitor
 - MYLAR** Mylar capacitor
 - CERAMIC** Ceramic capacitor
 - TANTAL** Tantalum capacitor
 - MF** Metallized film capacitor
 - MP** Metallized paper capacitor
 - OIL** Oil capacitor
- The unit "UF" is used in lieu of "μF"
- * Abbreviations of resistors (Parts No. with initial letters "R")
 - RC** Carbon composition resistor
 - RD** Carbon film resistor
 - FL-PROOF RD** Flame-proof carbon film resistor
 - RW** Wire wound power resistor
 - FL-PROOF RS** Flame-proof metal oxide film resistor
 - RN** Metal film resistor
 - FUSE-RESIST** Resistor with fuse function
 - 2B** Rated wattage 1/8W
 - 2E** Rated wattage 1/4W
 - 2H** Rated wattage 1/2W
 - 3A** Rated wattage 1W
 - 3D** Rated wattage 2W
 - 3F** Rated wattage 3W
 - 3G** Rated wattage 4W
 - 3H** Rated wattage 5W

- All resistor values are indicated with the unit (Ω) omitted.
- * Abbreviations common to capacitors and resistors.
 - C** ± 0.25pF (Used for capacitors only)
 - D** ± 0.5pF (Used for capacitors only)
 - F** ± 1%
 - G** ± 2%
 - J** ± 5%
 - K** ± 10%
 - M** ± 20%
 - Z** + 80%, - 20% (Used for capacitors only)
 - P** + 100%, - 0% (Used for capacitors only)
- Resistors RD (carbon composition resistors) are not listed in the parts list. For values, refer to the schematic diagram

Ref. No. 参照番号	Parts No. 部品番号	Description 部品名 / 規格	Re- marks 備考
BASIC C1 UNIT			
1	3A,3B	NO STOCK	MAIN CHASSIS
2	2A	NO STOCK	SUB PANEL
3	2B	NO STOCK	REAR PANEL
4	2A	NO STOCK	SHEET
5	2A	NO STOCK	ESCUTCHEON
6	2A	NO STOCK	BADGE
7	1A	NO STOCK	TERMINAL BOARD
8	3B	NO STOCK	MOUNTING HARDWARE
11	1A,1B	A01-0447-03	METALLIC CABINET
12	2A	A20-3251-02	FRONT PANEL ASSY
-	-	B46-0061-30	WARRANTY CARD
-	-	R46-0078-03	WARRANTY CARD
-	-	E50-4419-00	INSTRUCTION MANUAL
-	-	E50-4476-00	INSTRUCTION MANUAL
13	2A	B30-0256-05	LED
14	2A	C91-0079-05	CERAMIC 0.01UF AC125V
15	1B	E03-0007-05	AC OUTLET
16	1B	E30-0181-05	POWER CORD
16	1B	E30-0459-05	POWER CORD
17	1B	E30-0505-05	CORD WITH PLUG
-	-	H01-3461-04	CARTON BOX
-	-	H10-1538-13	POLYSTYRENE FIXTURE
-	-	H20-0452-04	COVER
-	-	H25-0078-04	BAG (235X315)
18	3A,3B	J02-0088-05	FOOT
18	3A,3B	J02-0089-05	FOOT
19	1B	J42-0083-05	BUSHING
20	2A	K23-0367-04	KNOB(TONE,LOUD,BALANCE)
21	2A	K27-0804-14	KNOB(POWER)
22	2A	K27-0805-04	KNOB(INPUT SELECTOR)
23	2A	K27-0806-04	KNOB(FILTER)
24	2A	K29-1104-04	KNOB(VOLUME)
25	1A	L01-2771-05	POWER TRANS
25	1A	L01-2776-05	POWER TRANS
26	2B	N08-0126-35	GND TERMINAL
27	1A	S31-2053-05	SLIDE SWITCH
28	2A	S40-1035-05	PUSH SWITCH
28	2A	S40-1037-05	PUSH SWITCH
29	2B	X08-2010-10	PRE AMP PCB ASSY
29	2B	X08-2012-71	PRE AMP PCB ASSY
30	2B	X11-1750-10	TONE AMP PCB ASSY
30	2B	X11-1752-71	TONE AMP PCB ASSY
PRE AMP (X08-2010-10)			
C1	2	C71-1710-15	CERAMIC 100PF J
C3	4	C52-1712-26	CERAMIC 0.0012UF K
C5	6	C24-0822-87	ELECTRO 2200UF 6.3wv
C7	8	C46-1711-35	MYLAR 0.011UF J
C9	10	C46-1739-35	MYLAR 0.039UF J
C11	12	C26-1733-57	NP-ELEC 3.3UF 50wv
C13	14	C46-1739-26	MYLAR 0.0039UF K
C15	16	C46-1710-36	MYLAR 0.01UF K
C17	18	C26-1733-47	ELECTRO 0.33UF 50wv
C19	20	C71-1710-15	CERAMIC 100PF J
C21	22	C46-1747-35	MYLAR 0.047UF J
C25	28	C24-1410-77	ELECTRO 100UF 25wv
C31	32	C71-1768-05	CERAMIC 68PF J

E: Scandinavia & Europe H: Audio Club K: USA P: Canada
S: South Africa T: England U: PX (Far East, Hawaii)
[UE]: AAFES (Europe) X: Australia M: Other Areas

* New Parts

PARTS LIST

Parts without Parts No. are not supplied.

Les articles non mentionnés dans le Parts No. ne sont pas fournis.

Teile ohne Parts No. werden nicht geliefert.

Ref. No. 参照番号	Parts No. 部品番号	Description 部品名 / 規格	Re- marks 備考
C33 -42	C71-1718-15	CERAMIC 180PF J	
C43 ,44	C52-1722-26	CERAMIC 0,0022UF K	
C45	C24-1710-57	ELECTRO 1UF 50wv	
-	E13-0216-05	PHONO JACK	
101 2B	F13-0432-05	PHONO JACK	
102 2B	E13-0618-05	PHONO JACK	
L1 ,2	L40-1511-43	INDUCTOR	
R41 ,42	H42-1247-95	FL-PROOF RD4,7 J 2E	
VR1	R06-5095-05	POTENTIOMETER	*
VR2	R06-5089-05	POTENTIOMETER	*
RL1	S51-2056-05	RELAY	
S1	S42-6014-05	PUSH SWITCH	*
S2	S40-2152-05	PUSH SWITCH	*
D1 ,2	V11-4100-30	WZ-197	
D3	V11-0271-05	1S2076	
IC1	V30-0344-40	NJM4560D-N	
Q1 -4	V09-0158-20	2SK170(BL)	
Q5	V03-2590-30	2SC2590(Q,R,S)	
Q6	V01-1110-30	2SA1110(Q,R,S)	
Q7 ,8	V09-0127-40	2SK105(H,J)	
TONE AMP (X11-1750-10)			
C3 ,4	C25-1710-57	LL-ELEC 1UF 50wv	
C5 ,6	C71-1710-02	CERAMIC 10PF D	
C7 ,8	C24-0822-77	ELECTRO 220UF 6,3wv	
C9 ,10	C71-1710-15	CERAMIC 100PF J	
C11 ,12	C71-1768-05	CERAMIC 68PF J	
C13 ,14	C26-1422-67	NP-ELEC 22UF 25wv	
C15 ,16	C46-1715-45	MYLAR 0,15UF J	
C17 ,18	C46-1768-25	MYLAR 0,0068UF J	
C19 -22	C25-1710-57	LL-ELEC 1UF 50wv	
C23 ,24	C46-1715-45	MYLAR 0,15UF J	
C25 ,26	C26-1447-67	NP-ELEC 47UF 25wv	
C27 ,28	C71-1710-02	CERAMIC 10PF D	
C29 ,30	C71-1747-05	CERAMIC 47PF J	
C41 ,42	C54-2710-39	CERAMIC 0,01UF P	
C43 ,44	C24-6510-87	ELECTRO 1000UF 35wv	
C45 ,46	C24-1433-77	ELECTRO 330UF 25wv	
C47	C24-1447-77	ELECTRO 470UF 25wv	
C48 -49	C24-1247-67	ELECTRO 47UF 16wv	
C50	C74-1233-67	ELECTRO 33UF 16wv	
C51	C74-1210-77	ELECTRO 100UF 16wv	
R61	R42-1247-05	FL-PROOF RD47 J 2E	
R62	R47-5433-15	FL-PROOF RS330 J 3A	
R63	R47-5439-15	FL-PROOF RS390 J 3A	
R64 ,65	R47-5533-15	FL-PROOF RS330 J 3D	
R66	R42-1247-95	FL-PROOF RD4,7 J 2E	
VR1	R06-5088-05	POTENTIOMETER	*
VR2 ,3	R06-3029-05	POTENTIOMETER	*
D1 -3	V11-0295-05	W06B	
D4 ,5	V11-0271-05	1S2076	
D6 ,7	V11-4104-90	B2-182	
D8	V11-4104-80	WZ-125	
IC1	V30-0732-10	NJM2043D-D	
IC2	V30-0344-40	NJM4560D-N	
Q1	V03-2590-30	2SC2590(Q,R)	
Q2 -4	V03-2320-80	2SC2320(E,F,G)	
Q5	V03-2003-00	2SC2003	

Note:

Component and circuitry are subject to modification to insure best operation under differing local conditions. This manual is based on the U.S. (K) standard, and provides information on regional circuit modification through use of alternate schematic diagrams, and information on regional component variations through use of parts list.

A product of

TRIO-KENWOOD CORPORATION

Shionogi Shibuya Building, 17-5, 2-chome Shibuya, Shibuya-ku, Tokyo 150, Japan

KENWOOD U.S.A. CORPORATION

1315 E. Watsoncenter Rd, Carson, California 90745, U.S.A.
75 Seaview Drive, Secaucus, New Jersey 07094, U.S.A.

TRIO-KENWOOD CANADA INC.

1070 Jayson Court, Mississauga, Ontario, Canada L4W 2V5

TRIO-KENWOOD ELECTRONICS, N.V.

Leuvensesteenweg 504 B-1930 Zaventem, Belgium

TRIO-KENWOOD ELECTRONICS GmbH

Rudolf-Braas-Str 20, 6056 Heusenstamm, West Germany

TRIO-KENWOOD FRANCE S.A.

5, Boulevard Ney, 75018 Paris, France

TRIO-KENWOOD AG

Unterboesch 6331 Huenenberg/ZUG Switzerland

TRIO-KENWOOD (AUSTRALIA) PTY. LTD.

4E Woodcock Place, Lane Cove, N.S.W. 2066, Australia

KENWOOD & LEE ELECTRONICS, LTD.

Wang Kee Building, 5th Floor, 34-37, Cannaught Road, Central, Hong Kong

E: Scandinavia & Europe H: Audio Club K: USA P: Canada

S: South Africa T: England U: PX (Far East, Hawaii)

UE: AAFES (Europe) X: Australia M: Other Areas